

ZAXIS130



HYDRAULIC EXCAVATOR

Model Code : ZX130-5G

Engine Rated Power : 66.0 kW (88.5 HP)

Operating Weight : ZX130-5G : 12 200 - 12 800 kg

Backhoe Bucket : ISO Heaped : 0.19 - 0.59 m³

ZAXIS Empower your Vision.

Hitachi Construction Machinery Americas introduces a new level of efficiency, safety, and cost-effectiveness to your construction site with the ZAXIS series of Hydraulic Excavators. ZAXIS offers dependable solutions including impressive fuel efficiency, agile maneuverability, and user-friendly operation. Our expertise shines through features like the optimized hydraulic system and engine technology. With ZAXIS, you benefit from high quality, reduced fuel consumption, and exceptional durability, all contributing to lower operating expenses. ZAXIS, continually evolving, is dedicated to optimizing conditions to help you achieve results and foster future growth.



More Production with Less Fuel

Page 4-5

- 8% reduction in fuel consumption, 4% increase in production
- More fuel reduction in the ECO mode
- Swift front movements with HIOS III hydraulics
- Powerful lifting operation
- Power boost
- Boosted traction force



High Level Operator Comfort

Page 8-9

- Comfortable operating environment
- Comfort-designed operator seat
- Robust cab
- Easy-to-use multifunction monitor



Pursuits of Performance and Durability

Page 6-7

- Prestige R&D and quality control
- Durable, reliable engine
- Rock-solid, durable front attachment
- Strengthened undercarriage
- Proven upperstructure



Simplified Maintenance

Page 10-11

- Dust-proof indoor net
- Grouped remote inspection points
- Attractive, robust body
- Low life cycle costs



Reliable Solutions, Various Versions

Page 12-13

- Easy to use attachments



ConSite

Page 16-17

- Automatic Data Report Service



Support Chain

Page 14-15

- Remote fleet management with Global e-Service
- Parts and service



Note: The photos in this brochure show excavators equipped with 3.01 m reinforced arm, 0.45 m³ bucket.

More Production with Less Fuel

8% Reduction in Fuel Consumption, 4% Increase in Production

ZAXIS is a fuel-thrifty excavator that can reduce fuel consumption by 8% while increase production by 4%, compared to the precedent ZX120-1, thanks to the HIOS III hydraulic system and engine control system, thereby reducing emissions.

More Fuel Reduction in the ECO mode

The ECO mode, economical mode, gives high productivity with less fuel and can cut fuel consumption by 14% compared to the PWR mode.



Swift Front Movements with HIOS* III Hydraulics

Operating speed increases with less fuel consumption thanks to the HIOS III hydraulic system, developed by industry-leading hydraulic technologies and a wealth of experience. Actuators work quickly by boom weight, without needing a regenerative circuit and pressure oil.

*Human & Intelligent Operation System

Rapid Arm Roll-in

Arm roll-in speed increases by combined flow from arm and boom cylinders through regenerative valves for productive excavation.

Fast Arm Speed During Boom Lowering

Arm speed increases by boom weight during boom lowering, without needing pressure oil from a pump. That is, arm circuit flow is increased for higher arm speed, allowing for quick loading of a dump truck and positioning of the front.



Power Boost

The Power Boost allows the operator to surge 5% more digging force for powerful excavation by pressing its button on the control lever.

Boosted Traction Force

The traction force is increased by 15%, allows powerful traveling on rough ground.

Powerful Lifting Operation

The Auto Power Lift mode, which automatically surge lifting force by 6% when needed, allows for powerful lifting of buried concrete pipes or sheathing sheets.



Pursuits of Performance and Durability

Prestige R&D and Quality Control

Hitachi Construction Machinery is globally recognized for its technological expertise and outstanding product performance. Within the company, the global engineering team adheres to Japanese standards, boasting a proven track record of excellence in design and stress analysis, utilizing advanced technology systems and extensive production databases. The company operates a vast durability testing field spanning 427 hm², allowing for rigorous testing of new machines. Production incorporates automated process, such as robotic welding, painting, assembling, and transferring.



Computer-Aided Engineering



Main pump testing area



Mid-sized excavator assembly line



Main frame welding line



Simulation testing from operator seat



Durable, Reliable Engine

This engine has a track record showing impressive durability at countless tough job sites around the world.

The engine — associated with a rugged design, a direct fuel injection system and an elaborate governor — goes green, and complies with EU Stage II and US EPA Tier 2 emissions regulations.

The cooling system well keeps the engine cool. The cooling fan is improved to cool the engine more efficiently.

The ample-capacity intercooler and turbocharger help yield a whopping 66.0 kW (88.5 HP) output for higher production in shorter job schedule.



Rock-Solid, Durable Front Attachment

The brackets at the boom foot enhance its durability because of steel bushings added. Arm cylinder and boom cylinders (rod extend ends) cushion shocks at stroke ends to cut noise and extend service life.

Joint pins at the front attachment are tightly fit to reduce jolt and sound. The arm-bucket joint is protected by WC thermal spraying on its contact surfaces to reduce wear and jolt. HN bushings, utilized on joint pins, retain grease inside for longer greasing intervals. A reinforced resin thrust plate, provided at front attachment joints, helps reduce wearing noise.



Strengthened Undercarriage

The X-beam frame is made monolithically with fewer welds for higher rigidity and durability.

Idler brackets and travel motor brackets are both thickened for added durability.

Proven Upperstructure

The upperstructure frame is reinforced with the proven D-section skirt to increase rigidity against damage by obstacles.

The door catch is improved to shut the door tightly, reducing door rattling.



HN bushing

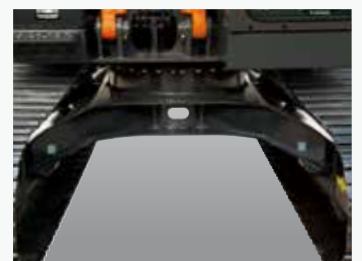

X-beam frame



Boom foot bracket



Reinforced resin thrust plates



WC thermal spraying

High Level Operator Comfort

Comfortable Operating Environment

You'll feel comfortable and confident, with plenty of leg space and excellent visibility when entering the cab. The compact console gives more leg space. The door pillar is shifted rearward by 70 mm to widen an entry space for easy access. A LED room light, interlocked with the door, turns on when the door opens. The front window is easily removed and stored overhead using slide rails. The overhead window is openable for ventilation. Lots more air vents for air conditioner are located strategically for uniform air circulation inside the cab. The control panel and control levers are arranged within easy reach of the operator. AM/FM radio and AUX port (optional) for a mobile music player are available for a long work day with less fatigue. All these designs focus on operator comfort.

Comfort-Designed Operator Seat

The luxury cloth seat is fitted with a headrest and arm rests for operator comfort. The seat can be adjusted in multiple ways, sliding and reclining, to suit operator's size and preferences. The seat can slide rearward by 40 mm more for added leg space. The air suspension seat with a heat pad is optional.

Robust Cab

The robust cab, meeting the OPG (Top Guard Level 1), protects the operator from falling objects. The pilot control shut-off lever is provided with the neutral engine start system that permits engine starting only when the pilot control shut-off lever is in Lock position. The engine is lockable by entering a password through the 10-key panel.



Control panel



Large storage space

Easy-to-Use Multifunction Monitor

The multi-language, multifunction monitoring system is composed of a 7-inch high-resolution color monitor and a multifunction controller. The monitor allows the operator to check varying operating variables: coolant temperature, fuel level, work mode, full-auto air conditioner, AM/FM radio, rear view monitor camera (optional), maintenance support, and attachment flow adjustment. Menu items can be selected and adjusted by a multifunction controller on the control panel. A rear view monitor camera always displays the view behind the machine.





Simplified Maintenance



Dust-Proof Net

A dust-proof net, provided at the front of radiator, can be easily removed and cleaned with compressed air.

Grouped Remote Inspection Points

Service points are concentrated inside left and right covers that are readily accessible from ground level for convenient servicing and inspection, including water draining from the fuel tank, replenishment of coolant, and replacement of filters. The fuel tank is anti-corrosion coated on its inside, and has a large cleaning port at the bottom. These wise designs effectively keep fuel clean, and ease servicing. Handrails are provided at convenient locations for easy riding on the upperstructure. Plenty slip-resistant plates are located for safe maintenance.

Attractive, Robust Body

Side frame tops of the undercarriage are sloped to let muck slide away. Track adjuster greasing ports are repositioned for easier lubrication, and well protected from muck packing.



Grouped remote filters and inspection points



Fuel tank water drainage cock



Dust-proof net



Low Life Cycle Costs

Service intervals are long enough to slash maintenance costs.

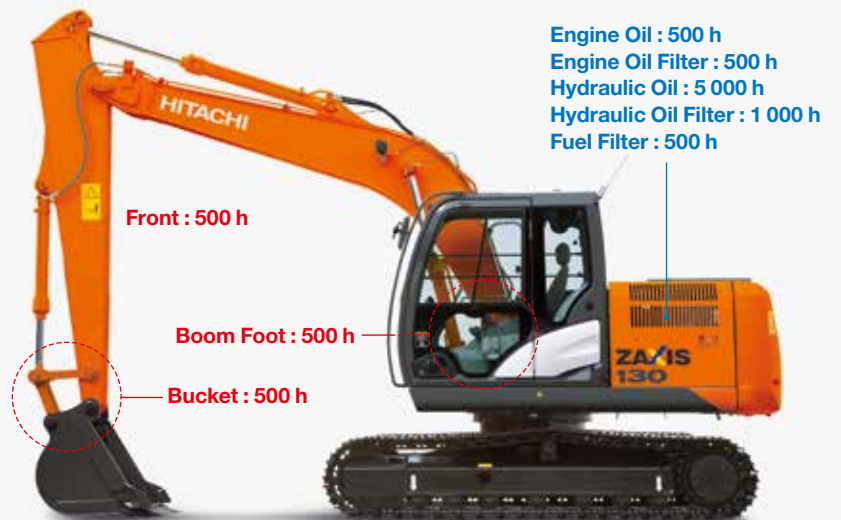

Lubricant

Consumables

Stated hours may vary depending on machinery usage - please refer to the operator manual and specific bucket lubrications before use.

Note: Periodic inspection is required to check oil contamination and likes.

Support Chain

Support Chain is a full customer support system offered after buying a machine.

Remote Fleet Management with Global e-Service

Easy Access to On-Site Machines through the Internet

This on-line fleet management system allows you to access each on-site machine from a PC in your office. You can get its operating information and location to increase productivity of the fleet and reduce downtime. Operating data and log are sent to a Hitachi Construction Machinery server for processing, and then to customer and dealers around the world. This system is available 24 hours a day, all the year around.

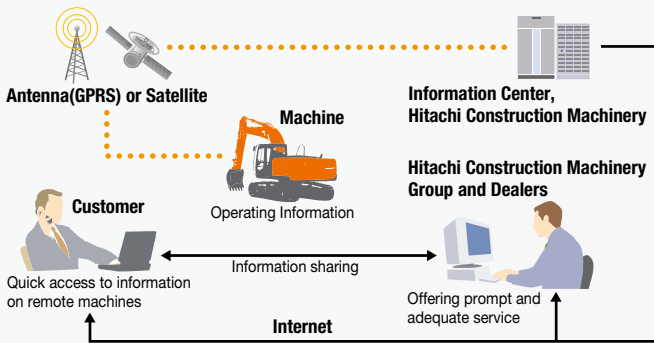

Note: In Some Regions, Global e-Service Is Not Available by Local Regulations.

Main Features of Global e-Service

Functions

Global e-Service provides easy access to a machine on site, conveying operating information and log, including daily operating hours, fuel level, temperatures, pressures, and likes.

Maintenance

Maintenance data and log are displayed on a easy-to-read monitor screen, suggesting recommended maintenance for efficient fleet management.

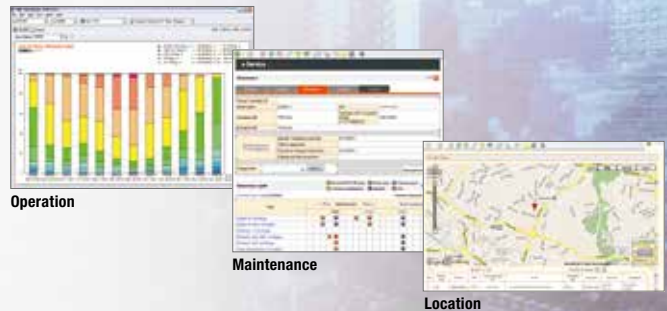

Parts and Service

Hitachi Construction Machinery's full customer support is available every area on the globe for full customer satisfaction through authorized local dealers.

Parts

Hitachi Construction Machinery's Global Online Network, a parts supply system, is linked with Japan Parts Center, overseas depots and over 150 dealers abroad to deliver on-line parts information, including in-stock parts, order receptions, shipments and delivery period of over one million parts and components.

Genuine Parts

Genuine parts, meeting stringent quality standards, are guaranteed according to Hitachi Construction Machinery's warranty standards. The use of genuine parts, including engine, fuel, hydraulic oil and filters, may slash running costs, and extend machine life.

Ground Engaging Tools (GETs)

Hitachi Construction Machinery provides an array of

Ground Engaging Tools developed and built for a variety of applications. Using high-quality, well-maintained GETs will help you get customers' trust.

Note: Some dealers do not handle GETs.

Remanufactured Components

Hitachi Construction Machinery's components are remanufactured according to the stringent remanufacturing standards at factories around the world. They have high quality equivalent to new ones, and backed up by Hitachi Construction Machinery's warranty system.

Note: Some dealers do not handle Remanufactured Components.

Service

Extended Warranty — HELP

Hitachi Construction Machinery's Standard Warranty System is available on all new ZAXIS excavators and ZW wheel



loaders In addition, We offer Extended Life Programs (HELPS) to suit customer expectations – protecting machines under tough operating conditions, avoiding unexpected downtime, and reducing repair costs.

Note: Warranty conditions vary by equipment.

Diagnostic Tools – Maintenance Pro

Electronic control system needs quick on-site solutions, apart from mechanical repairs. The Maintenance Pro can diagnose machine failures in a short time by plugging a PC into a failed machine.

Technical Training

On-site servicing matters despite locations to keep the machine at peak performance and reduce downtime. Technical Training Center (TTC), located in Japan, educates and trains service technicians and service support personnel coming from authorized dealers and factories on the globe according to the international training programs.

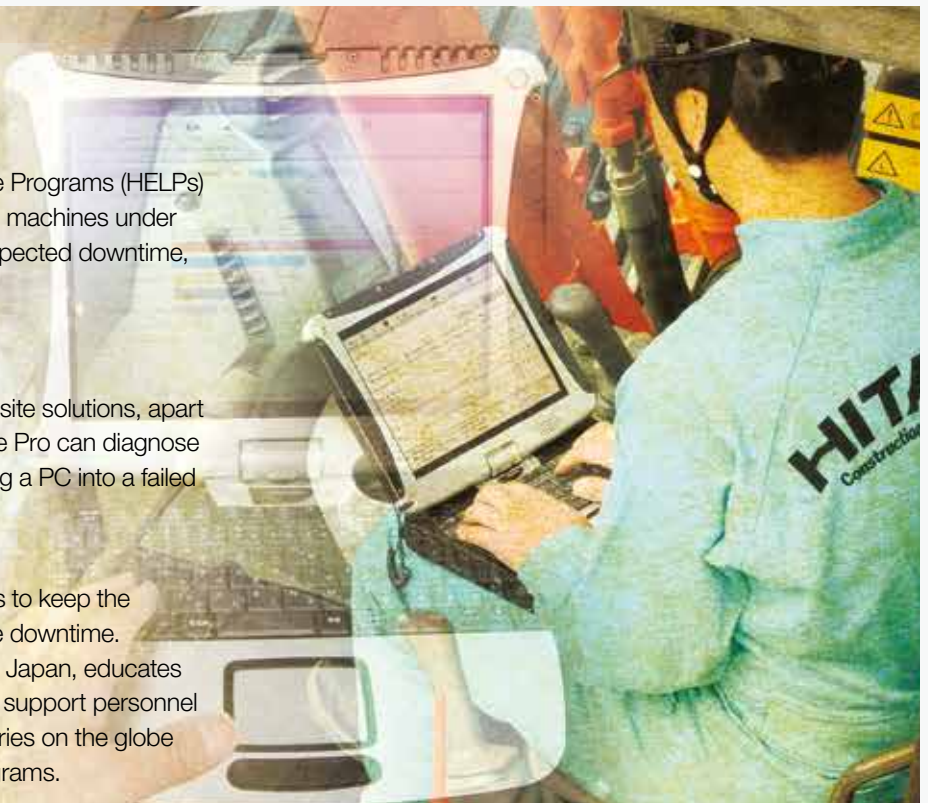

ConSite

ConSite is an automatic Data Report Service that sends a monthly e-mail summarising the information from Global e-Service for each of your machines.

Available in more than 30 languages, ConSite includes a detailed analysis of the operational data, ratios and hours. This Monthly Report is also stored on the Owner's Site for ease of reference.

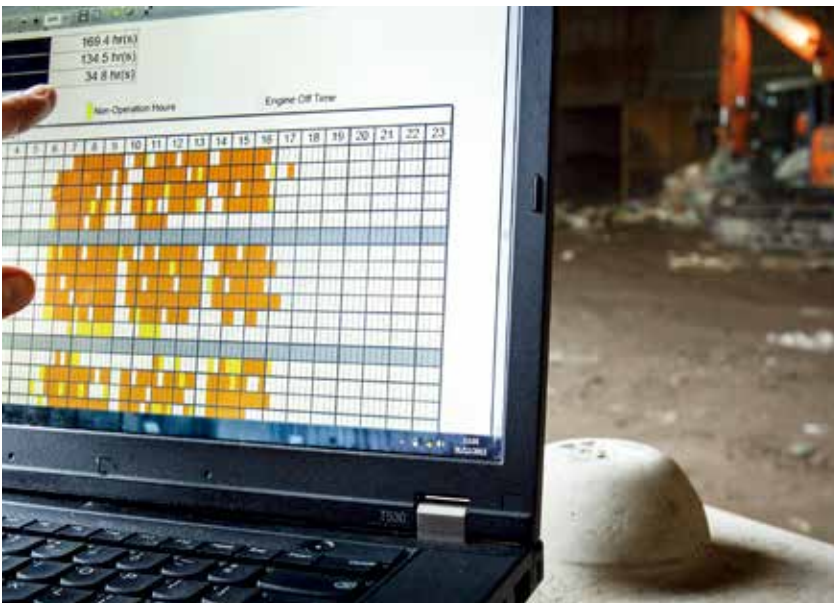

A remote fleet monitoring system to improve overall performance

ConSite

Our ConSite Data Report Service sends you a monthly e-mail to summarise the information available on Global e-Service for each of your machines. It includes a detailed analysis of operational data, ratios and hours, so you can see how productive and efficient your machines have been in the past month. All the information from the report is stored in the Owner's Site as well, for easy reference.

Further into the ConSite Report, you'll see non-operation and swing efficiency ratings and ratios. These compare the machine's performance against the same model class from all Hitachi Construction Machinery owners in your region.

The monthly and total number of hours are divided for front, swing, travel and attachment operations. This will help you to determine the actual usage of your machine and maintenance planning.

The monthly analysis of these variables is compared to the total lifetime of the machine in a user-friendly chart. A line graph shows the actual and projected number of hours, which helps you to manage maintenance requirements.

ConSite can also help you in the unlikely event of a fault. It will send you and your authorised dealer an Emergency Alarm Report, so you can both respond quickly in order to minimise unscheduled downtime.

We created ConSite to improve your business operations, and enable you to analyze the productivity and efficiency of your equipment. The information it provides on machine usage is intended to help you with maintenance planning and also promotes proactive support from your dealer. Ultimately, it provides you with confidence in your ZAXIS excavators, ZW wheel loaders, and peace of mind to focus on other areas of your business.

Owner's Site

You can find out all you need to know about your fleet of Hitachi construction machinery in the field from the comfort of your home or office, thanks to Owner's Site. This online management tool, available at www.globaleservice.com, is user-friendly and offers extensive and detailed information on your Zaxis Excavators and ZW Wheel Loaders.

The data is displayed in a flexible layout, so you can create machine groups per job site or select relevant information, depending on your requirements. As every project is different, you can customize the Owner's Site Dashboard to view data quickly and easily.



Scan this code for our
ConSite function explanation
& case study video



Key Features

- Check each of your machines from your office – 24/7
- Have a remote insight into fuel consumption
- Check the current and previous locations and movements of your machine(s)
- See maintenance status and items due for renewal on each of your machines
- Receive e-mail notifications for any machine alerts, unexpected movements and so on

SPECIFICATIONS

ENGINE

Model	Isuzu CC-4BG1T
Type	4-cycle water-cooled, direct injection
Aspiration	Turbocharged, intercooled
No. of cylinders	4
Rated power	
ISO 9249, net	66.0 kW (88.5 HP) at 2 150 min ⁻¹ (rpm)
SAE J1349, net	66.0 kW (88.5 HP) at 2 150 min ⁻¹ (rpm)
Maximum torque	347 Nm (35.4 kgfm) at 1 600 min ⁻¹ (rpm)
Piston displacement ..	4.329 L
Bore and stroke	105 mm x 125 mm
Batteries	2 x 12 V / 55 Ah

HYDRAULIC SYSTEM

Hydraulic Pumps

Main pumps	2 variable displacement axial piston pumps
Maximum oil flow ..	2 x 116 L/min
Pilot pump	1 gear pump
Maximum oil flow ..	36.1 L/min

Hydraulic Motors

Travel	2 variable displacement axial piston motors
Swing	1 axial piston motor

Relief Valve Settings

Implement circuit	34.3 MPa (350 kgf/cm ²)
Swing circuit	32.3 MPa (330 kgf/cm ²)
Travel circuit	34.3 MPa (350 kgf/cm ²)
Pilot circuit	4.0 MPa (41 kgf/cm ²)
Power boost	36.3 MPa (370 kgf/cm ²)

Hydraulic Cylinders

	Quantity
Boom	2
Arm	1
Bucket	1

UPPERSTRUCTURE

Revolving Frame

D-section frame skirt for resistance to deformation.

Swing Device

Swash plate piston motor with planetary reduction gear is bathed in oil. Swing circle is single-row. Swing parking brake is spring-set/hydraulic-released disc type.

Swing speed	13.7 min ⁻¹ (rpm)
Swing torque	34 kNm (3 470 kgfm)

Operator's Cab

Independent spacious cab, 1 005 mm wide by 1 675 mm high, conforming to ISO* Standards.

* International Organization for Standardization

UNDERCARRIAGE

Tracks

Heat-treated connecting pins with dirt seals. Hydraulic (grease) track adjusters with shock-absorbing recoil springs.

Numbers of Rollers and Shoes on Each Side

Upper roller	1
Lower rollers	7
Track shoes	44

Travel Device

Each track driven by 2-speed axial piston motor. Parking brake is spring-set/hydraulic-released disc type. Automatic transmission system: High-Low.

Travel speeds	High : 0 to 5.5 km/h
	Low : 0 to 3.3 km/h

Maximum traction force .. 117 kN (11 900 kgf)

Gradeability .. 70% (35 degree) continuous

SERVICE REFILL CAPACITIES

Fuel tank	280.0 L
Engine coolant	19.0 L
Engine oil	15.8 L
Swing device	3.2 L
Travel device (each side)	4.0 L
Hydraulic system	170.0 L
Hydraulic oil tank	70.0 L

WEIGHTS AND GROUND PRESSURE

Operating weight and Ground pressure

			ZX130-5G*1	
Shoe type	Shoe width	Arm length	kg	kPa(kgf/cm ²)
Triple grouser	500 mm	2.52 m	12 200	38 (0.39)
		3.01 m	12 300	38 (0.39)
	600 mm	2.52 m	12 500	32 (0.33)
		3.01 m	12 600	33 (0.34)
	700 mm	2.52 m	12 700	28 (0.29)
		3.01 m	12 700	28 (0.29)
Trianglar	700 mm	2.52 m	12 500	27 (0.28)
		3.01 m	12 600	27 (0.28)
Flat	510 mm	2.52 m	12 700	39 (0.40)
		3.01 m	12 800	39 (0.40)
Pad crawler	500 mm	2.52 m	12 300	38 (0.39)
		3.01 m	12 400	38 (0.39)

*1 :Including 0.50 m³ (ISO heaped) bucket weight (410 kg) and counterweight (2 400kg).

WEIGHT: BASIC MACHINE

Basic Machine Weight and Overall width

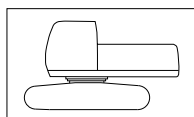

Excluding front-end attachment, fuel, hydraulic oil, coolant, etc., and including counterweight.

ZX130-5G

Shoe width	Weight	Overall width
500 mm	9 500 kg	2 490 mm
600 mm	9 800 kg	2 590 mm
700 mm	10 000 kg	2 690 mm

SPECIFICATIONS

WEIGHT: COMPONENTS

Component weights

	ZX130-5G
Counterweight	2 400 kg
Boom (with boom and arm cylinder)	1 220 kg
2.52 m arm (with bucket cylinder)	600 kg
3.01 m arm (with bucket cylinder)	670 kg
0.50 m ³ bucket	410 kg

BUCKET AND ARM DIGGING FORCES

Arm length	2.52 m	3.01 m
Bucket digging force* ISO	104 kN (10 600 kgf)	104 kN (10 600 kgf)
Bucket digging force* SAE : PCSA	91 kN (9 300 kgf)	91 kN (9 300 kgf)
Arm crowd force* ISO	69 kN (7 000 kgf)	61 kN (6 200 kgf)
Arm crowd force* SAE : PCSA	67 kN (6 800 kgf)	60 kN (6 100 kgf)

* At power boost

BACKHOE ATTACHMENTS

Boom and arms are of welded, box-section design. 4.60 m boom, 2.52 m and 3.01 m arms are available. Bucket is of welded steel structure. Side clearance adjust mechanism provided on the bucket joint bracket.

Buckets

Capacity	Width		No. Of teeth	Weight	Recommendation	
					ZX130-5G	
ISO heaped	Without side cutters	With side cutters			2.52 m arm	3.01 m arm
0.19 m ³	450 mm	570 mm	3	260 kg	◎	◎
0.30 m ³	580 mm	700 mm	3	310 kg	◎	◎
0.40 m ³	720 mm	840 mm	4	360 kg	◎	◎
0.45 m ³	800 mm	920 mm	5	390 kg	◎	○
0.50 m ³	890 mm	1 010 mm	5	410 kg	◎	*1 ○
0.59 m ³	950 mm	1 070 mm	5	430 kg	○	—
0.66 m ³	1 030 mm	—	5	430 kg	—	—
*2 0.50 m ³	890 mm	1 010 mm	5	480 kg	◎	*1 ○
*2 0.59 m ³	950 mm	1 070 mm	5	500 kg	○	—
One-point ripper			1	320 kg	●	—
Slope-finishing blade: Width 1 100 mm, length 1 600 mm			—	430 kg	◇	◇
V shape Bucket:			3	390 kg	○	○

*1 With 700 mm shoes only

*2 Reinforced bucket

◎ Suitable for materials with density of 2 000 kg/m³ or less

○ Suitable for materials with density of 1 600 kg/m³ or less

□ Suitable for materials with density of 1 100 kg/m³ or less

● Heavy-duty service

◇ Slope-finishing service

— Not applicable

SPECIFICATIONS

WORKING RANGES

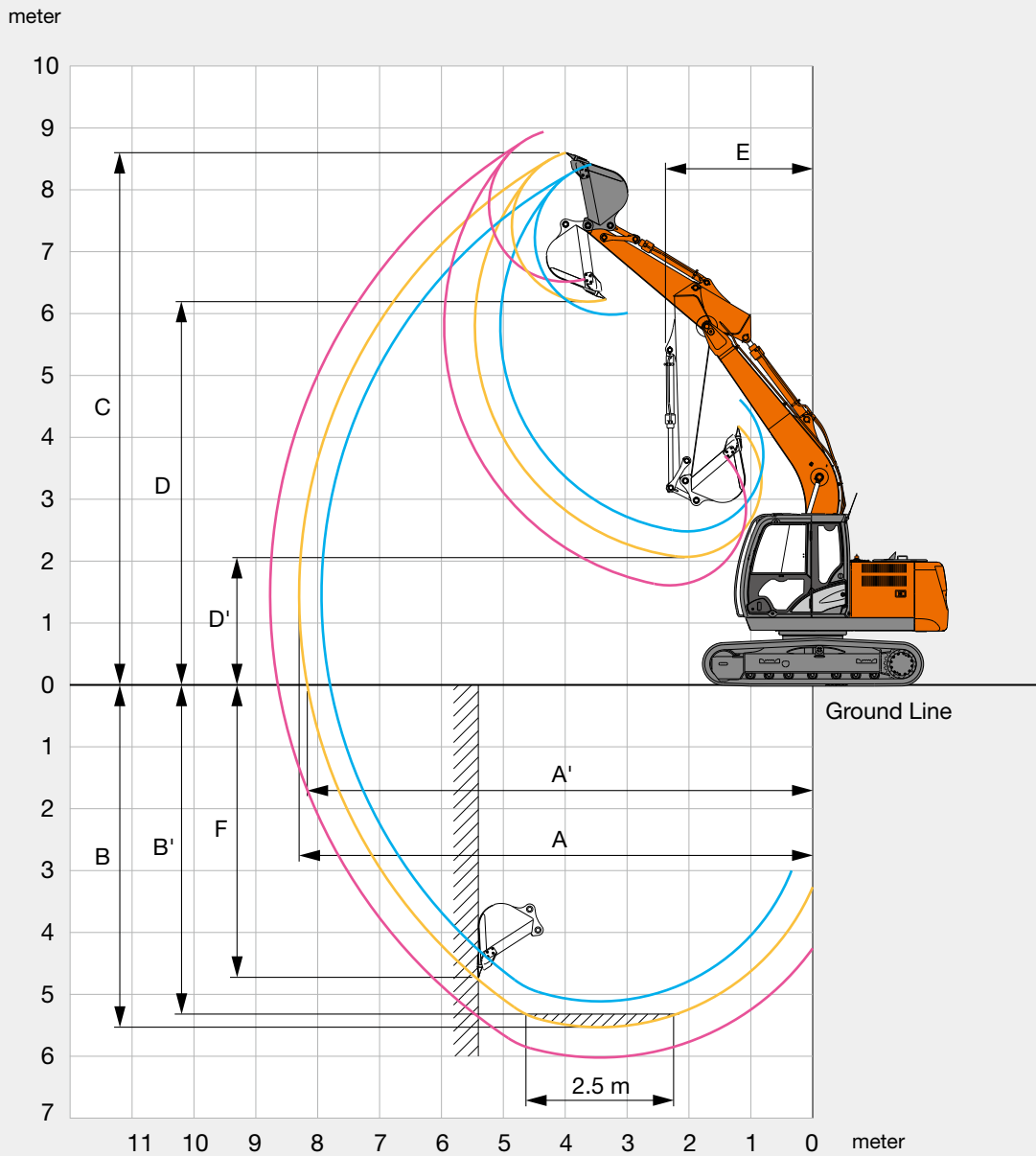

Unit: mm

ZX130-5G		
Arm length	2.52 m	3.01 m
A Max. digging reach	8 300	8 770
A' Max. digging reach (on ground)	8 170	8 650
B Max. digging depth	5 540	6 030
B' Max. digging depth for 2.5 m level	5 310	5 840
C Max. cutting height	8 600	8 930
D Max. dumping height	6 190	6 520
D' Min. dumping height	2 070	1 610
E Min. swing radius	2 400	2 620
F Max. vertical wall digging depth	4 750	5 220

Excluding track shoe lug

SPECIFICATIONS

DIMENSIONS

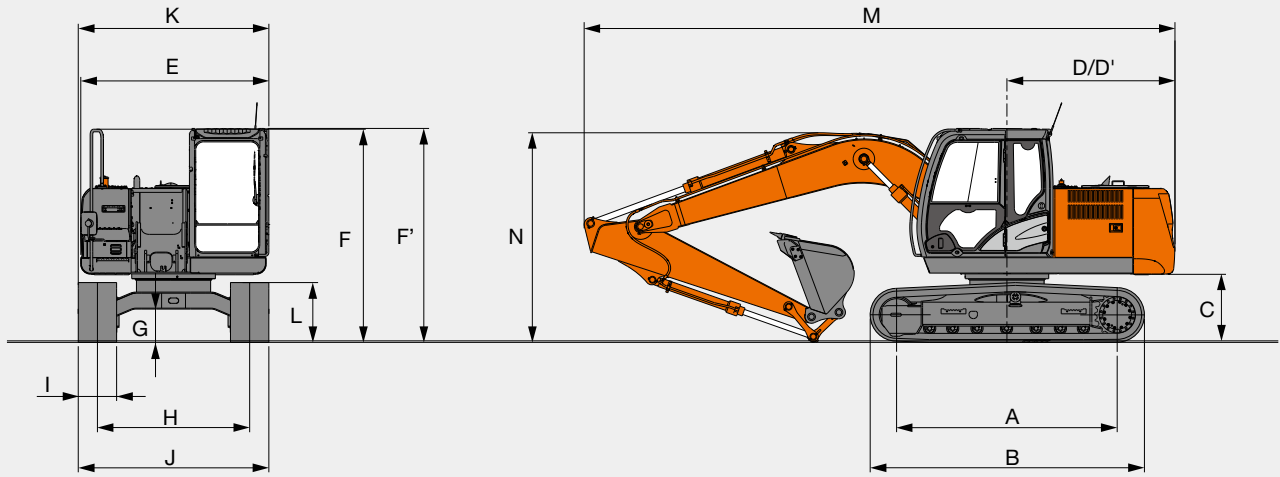

Unit: mm



Unit: mm











	ZX130-5G
A Distance between tumblers	2 880
B Undercarriage length	3 580
* C Counterweight clearance	840
D Rear-end swing radius	2 190
D' Rear-end length	2 190
E Overall width of upperstructure	2 490
F Overall height of cab	2 790
F' Overall height of upperstructure	2 790
* G Min. ground clearance	410
H Track gauge	1 990
I Track shoe width	500
J Undercarriage width	2 490
K Overall width	2 490
* L Track height with triple grouser shoes	780
M Overall length	
With 2.52 m arm	7 700
With 3.01 m arm	7 710
N Overall height of boom	
With 2.52 m arm	2 750
With 3.01 m arm	2 740

* Excluding track shoe lug G: Triple grouser shoe

LIFTING CAPACITIES (Without Bucket)

ZX130-5G

 Rating over-front  Rating over-side or 360 degrees Unit : kg

Conditions	Load point height m	Load radius										At max. reach		
		1.5 m		3.0 m		4.5 m		6.0 m		7.5 m		meter		
														
Boom 4.60 m Arm 2.52 m counterweight 2 400 kg shoe 500 mm	4.5					*3 590	3 530	3 170	2 210			*2 320	2 000	6.36
	3.0			*5 930	*5 930	*4 390	3 340	3 110	2 150			*2 310	1 720	6.90
	1.5			*8 090	5 610	4 650	3 110	3 010	2 060			2 350	1 610	7.07
	0 (Ground)			*6 520	5 320	4 470	2 950	2 920	1 980			2 390	1 630	6.92
	-1.5	*4 660	*4 660	8 820	5 280	4 400	2 880	2 890	1 950			2 650	1 800	6.40
	-3.0	*8 560	*8 560	*7 890	5 380	4 440	2 920					3 380	2 280	5.44
	-4.5													
Boom 4.60 m Arm 3.01 m counterweight 2 400 kg shoe 500 mm	6.0											*2 140	*2 140	5.97
	4.5					*3 110	*3 110	*3 160	2 240			*2 000	1 760	6.88
	3.0			*4 920	*4 920	*3 930	3 390	3 120	2 160			*1 990	1 530	7.38
	1.5			*7 740	5 750	4 690	3 140	3 010	2 060	2 130	1 450	*2 090	1 440	7.54
	0 (Ground)			*7 120	5 310	4 460	2 940	2 900	1 960			2 140	1 450	7.39
	-1.5	*4 120	*4 120	8 730	5 200	4 350	2 840	2 850	1 910			2 340	1 580	6.92
	-3.0	*7 180	*7 180	*8 440	5 250	4 360	2 840	2 880	1 940			2 860	1 920	6.04
-4.5			*6 120	5 460	*3 780	2 990					*3 770	2 990	4.50	

Notes: 1. Ratings are based on ISO 10567.

- Lifting capacity does not exceed 75% of tipping load with the machine on firm, level ground or 87% full hydraulic capacity.
- The load point is the center-line of the bucket pivot mounting pin on the arm.
- *Indicates load limited by hydraulic capacity.
- 0 m = Ground.

For lifting capacities, subtract bucket and quick hitch weight from lifting capacities without bucket.

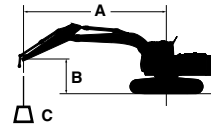

- A: Load radius
- B: Load point height
- C: Lifting capacity

EQUIPMENT

Standard and optional equipment may vary by country, so please consult authorized dealer for details.

● : Standard equipment

○ : Optional equipment

	ZX130-5G
ENGINE	
Air cleaner double filters	●
Auto idle system	●
Cartridge-type engine oil filter	●
Cartridge-type fuel pre-filter	●
Cartridge-type fuel main filter	●
Dry-type air filter with evacuator valve (with air filter restriction indicator)	●
ECO/PWR mode control	●
Engine warm-up device	●
Fan guard	●
Water separator	●
Pre-cleaner	○
Dust-Proof net	●
Radiator reserve tank	●
50 A alternator	●

	ZX130-5G
HYDRAULIC SYSTEM	
Auto power lift	●
Control valve with main relief valve	●
Full-flow filter	●
High mesh full flow filter with restriction indicator	○
Pilot filter	●
Power boost	●
Suction filter	●
One extra port for control valve	●
Work mode selector	●

	ZX130-5G
CAB	
All-weather sound suppressed steel cab	●
AM-FM radio with 2 speakers	●
Ashtray	●
Auto control air conditioner	●
AUX. terminal and storage	○
Cab (Center pillar reinforced structure)	●
Drink holder	●
Drink holder with hot & cool	●
Electric double horn	●
Engine shut-off lever	●
Evacuation hammer	●
Fire extinguisher bracket	○
Floor mat	●
Footrest	●
Front window washer	●
Front windows on upper, lower and left side can be opened	●
Lower cab front guard	○
Upper cab front guard	○
Glove compartment	●
Hot & cool box	●
Intermittent windshield wipers	●
Key cylinder light	●
LED room light with door courtesy	●
OPG top guard Level I (ISO10262) compliant cab	●
Pilot control shut-off lever	●
Rear tray	●
Retractable seat belt	●
ROPS (ISO12117-2 : 2008) compliant cab	○
Rubber radio antenna	●
Seat : Fabric seat	●
Seat : mechanical suspension seat	○
Seat : air suspension seat with heater	○
Seat adjustment part : backrest, armrest, height and angle, slide forward / back	●
Short wrist control levers	●
4 fluid-filled elastic mounts	●
24V cigarette lighter	●

	ZX130-5G
MONITOR SYSTEM	
Alarm buzzers: overheat, engine oil pressure	●
Alarms: overheat, engine warning, engine oil pressure, alternator, minimum fuel level, hydraulic filter restriction, air filter restriction, etc	●
Display of meters: coolant temperature, hour, clock	●
Other displays: work mode, auto-idle, glow, rearview monitor, operating conditions, etc	●
32 languages selection	●

LIGHTS	
Additional cab roof front lights	○
Additional boom light	○
2 working lights	●

UPPER STRUCTURE	
Electric fuel refilling pump	○
Fuel level float	●
Hydraulic oil level gauge	●
Rear view camera	○
Rear view mirror (right & left side)	●
Swing parking brake	●
Tool box	●
Undercover	●
6.0 mm reinforced undercover	○
Utility space	●
2 400 kg counterweight	●
3 000 kg counterweight	○
2 x 55 Ah batteries	●

	ZX130-5G
UNDERCARRIAGE	
Bolt-on sprocket	●
Reinforced track links with pin seals	●
Travel motor covers	●
Travel parking brake	●
6.0 mm reinforced track undercover	○
Track guard (each side) and hydraulic track adjuster	●
Upper and lower rollers	●
1 track guard	○
2 track guards	○
4 tie down hooks	●
500 mm shoes	○

FRONT ATTACHMENTS	
Centralized lubrication system	●
Dirt seal on all bucket pins	●
Flanged pin	●
HN bushing	●
Reinforced resin thrust plate	●
WC (tungsten-carbide) thermal spraying	●
0.50 m ³ bucket (ISO heaped)	●
2.52 m arm	●
4.60 m boom	●

ATTACHMENTS	
Attachment basic piping	○
Breaker and crusher piping	○
High mesh full flow filter with restriction indicator	○
Parts for breaker and crusher	○
2 pump combined flow for attachment basic piping	○

MISCELLANEOUS	
Lockable fuel refilling cap	●
Lockable machine covers	●
Onboard information controller	●
Skid-resistant tapes, plates and handrails	●
Standard tool kit	●
Travel direction mark on track frame	●
Global e-Service	●



Built on the foundation of superb technological capabilities, Hitachi Construction Machinery is committed to providing leading-edge solutions and services to contribute as a reliable partner to the business of customers worldwide.



Before using a machine with a satellite communication system, please make sure that the satellite communication system complies with local regulations, safety standards and legal requirements. If not so, please make modifications accordingly.

These specifications are subject to change without notice. Illustrations and photos show the standard models, and may or may not include optional equipment, accessories, and all standard equipment with some differences in color and features. Consult your local dealer for optional equipment and features. Before use, read and understand the Operator's Manual for proper operation.